

AQUA ENERGY

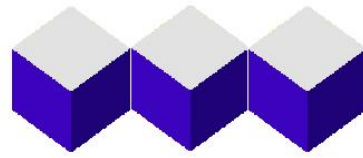

"WATERJET SOLUTIONS"

Hand Held Air Operated Dual Trigger Control Gun

Pressures to 2759 bar (40,000 psi)

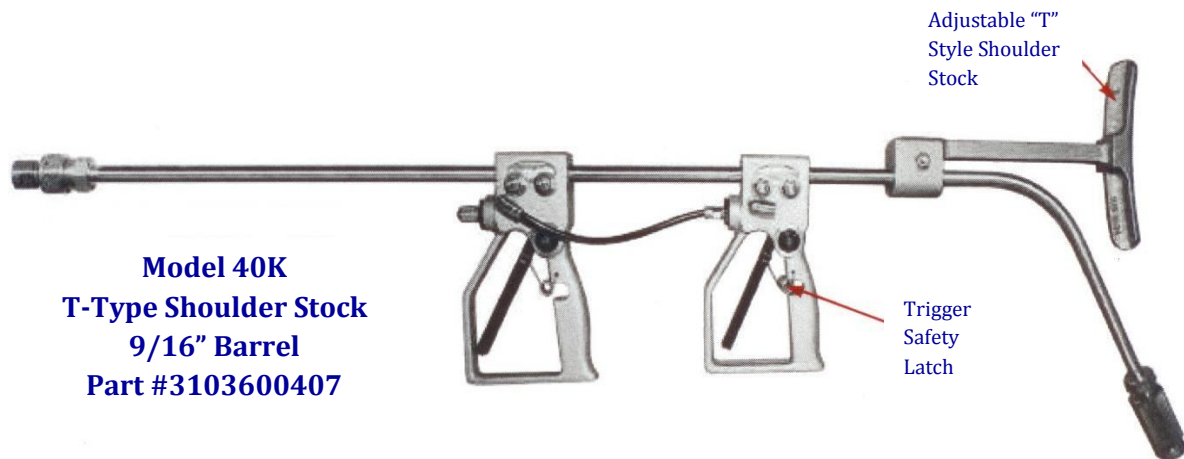

Aqua Energy proudly introduces the **NEW AIR OPERATED CONTROL SYSTEM** for UHP water jetting. Use it in place of expensive rotary air guns in most applications.

The air operated control gun works with your existing tumble box just like the current air rotary gun. You can combine it with the 40K Barracuda or any other UHP rotary nozzle for surface preparation and coating removal.

The new air gun features:

- No valves or seats in the gun
- No high pressure seals or swivels
- No rotating barrels or air motors to repair
- Ability to run single or multi-guns depending on your tumble box system
- No cartridge to replace

Standard overall length with 36" barrel is 72.5 inches (1841mm)

Weighs only 7.04 kg (15.54 lbs)

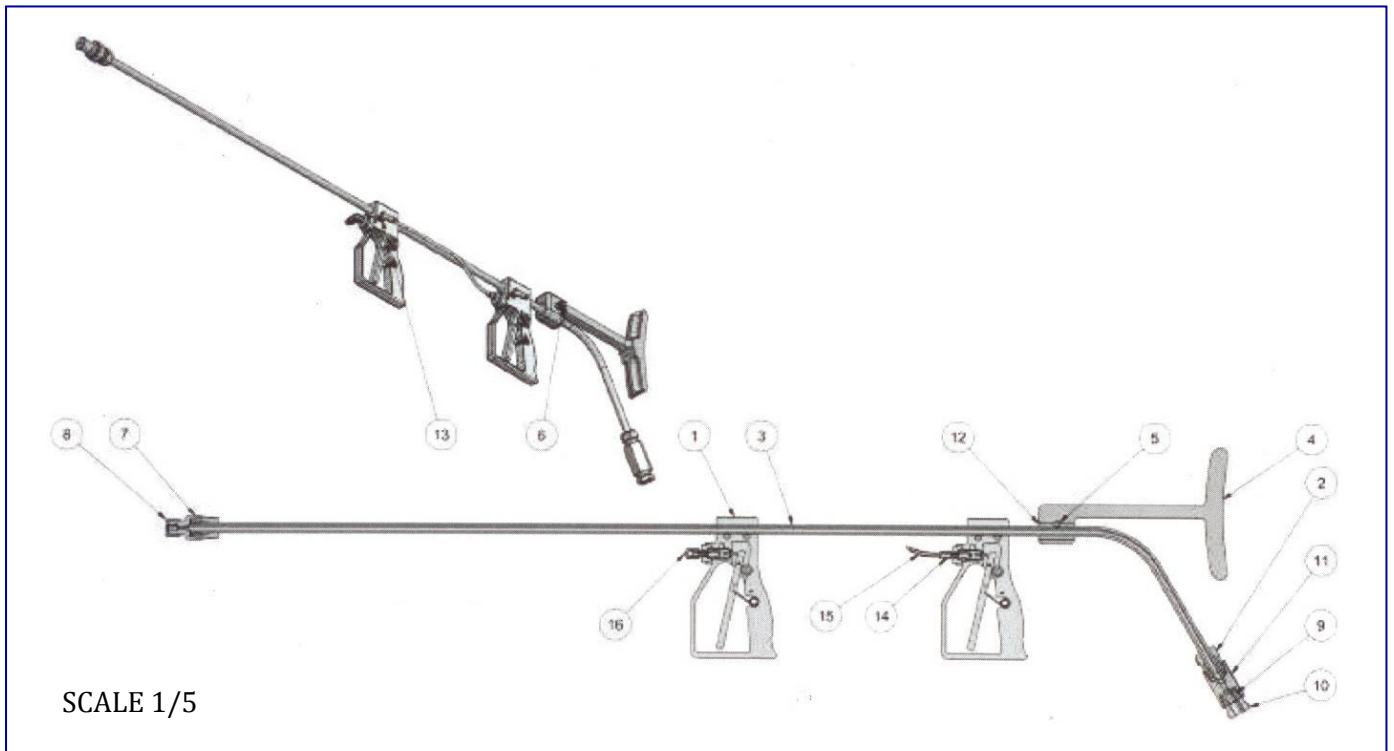
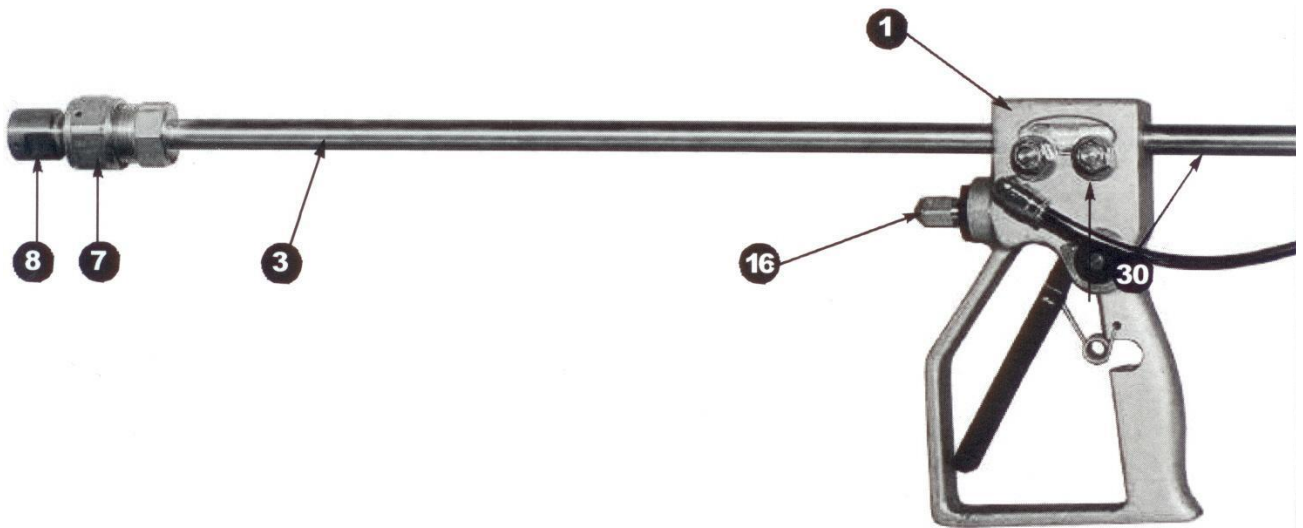

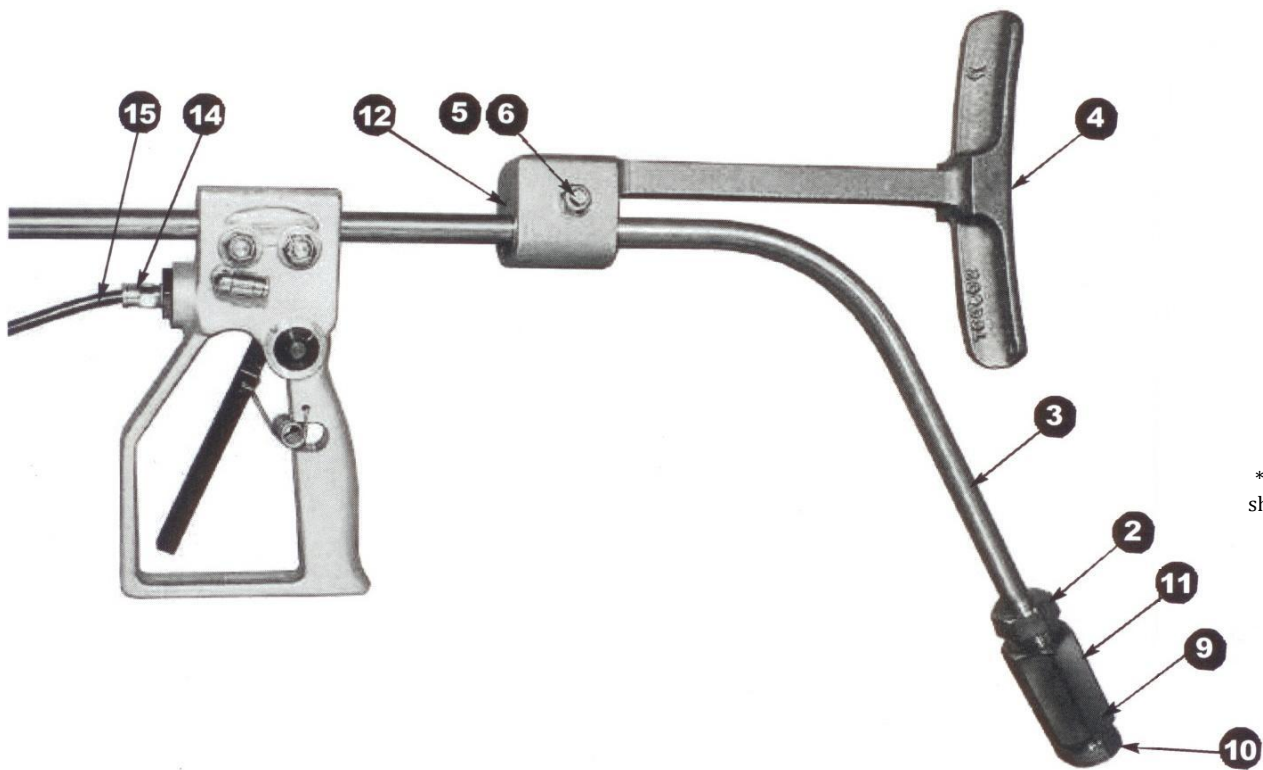

* Not shown

ITEM	DESCRIPTION	QUANTITY	PART NO
COMPLETE	Dual Trigger Air-Op Control Gun, 9/16" Barrel	1	3103600407
1	Handle, Air-Op Gun, 9/16"	2	3103610001
2	Gland Nut, 9/16", HP, Anti-Vibration	2	3620144
3	Nipple, Air-Op Gun, 40K, 48" Long	1	3103611036
4	T-Style Shoulder Stock	1	77700602-2
5	Cam Stud Assy	1	77700624
6	Lock Nut, 9/16" x 16	1	77513038
7	Nozzle Holder Body, 40K HGLT	1	77700326-1
8	Nozzle Holder Wear Cap, 40K HGLT	1	77700326-2
9	Collar, 9/16" HP	1	3610012
10	Gland, 9/16" HP, 40K	1	3610045
11	Coupling, 9/16" HP, 40K	1	3620281
12	Sleeve, Shoulder Stock	1	77700638
13	Fitting, 1/8" MNPT x 1/4" Tube Prestoloc Swivel Elbow	2	77408661-1
14	Fitting, 1/8" MNPT x 1/4" Tube Prestoloc	1	77408661
15	Hose, 1/4" Push-Loc on Reel	48	77408650
16	Adapter, 1/8" NPTM to 9/16"-18 JIC 90° Elbow	1	1990719

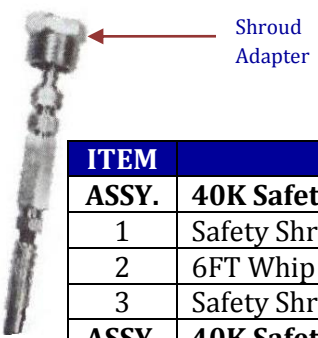
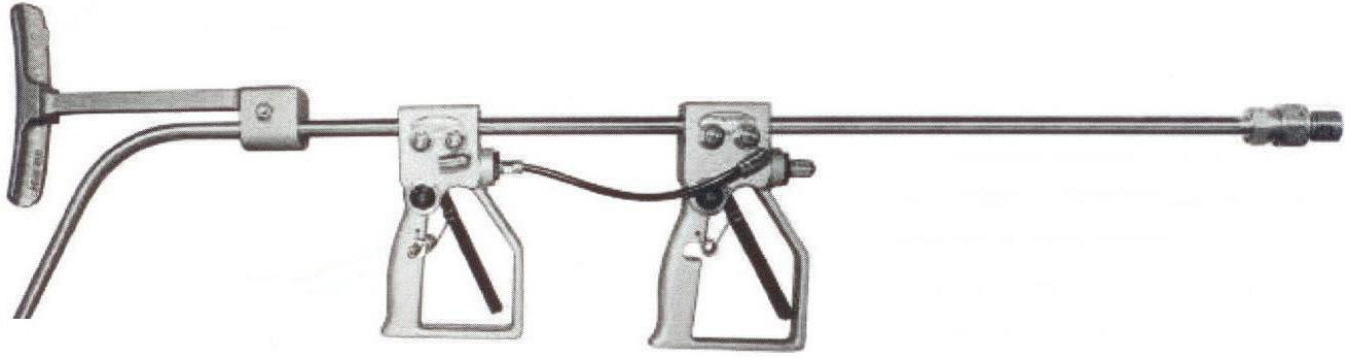

ITEM	DESCRIPTION	QTY	PART NO.
ASSY.	40K Safety Shroud With Whip Hose Assembly	1	77516069001
1	Safety Shroud Assembly, 40K	1	77516030
2	6FT Whip Hose (9/16"-18 thd Type M Swivel with burst shield)	1	77ST6105JJD006B
3	Safety Shroud Adapter, 40K	1	77516029
ASSY.	40K Safety Shroud With Whip Hose Assembly	1	77516069001
1	Safety Shroud Assembly, 40K	1	77516030
2	6FT Whip Hose (9/16" HP Tube Nipple with burst shield)	1	77ST8005JAJA006B
3	Safety Shroud Adapter, 40K	1	77516029

Applications/Features:

Since the safety of the operator is the first consideration when water blasting, the **Aqua Energy Safety Shroud** is designed to protect the operator from dangerous hose failures occurring near the gun. One should NEVER connect an un-shrouded hose directly to a water blasting gun. ALWAYS connect a whip hose and safety shroud to the gun first, then connect the appropriate hose to the other end of the shroud/whip hose with a quick coupling. The **Aqua Energy Safety Shroud** features a nitrile outer cover which is water, oil and soil resistant. The inner material consists of high strength braided stainless steel. The 2759 bar (40,000 psi) shrouds also include a layer of woven Kevlar™ for superior strength.

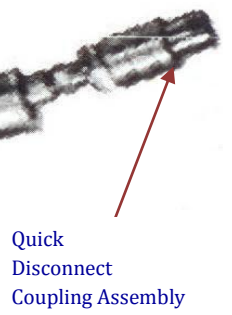
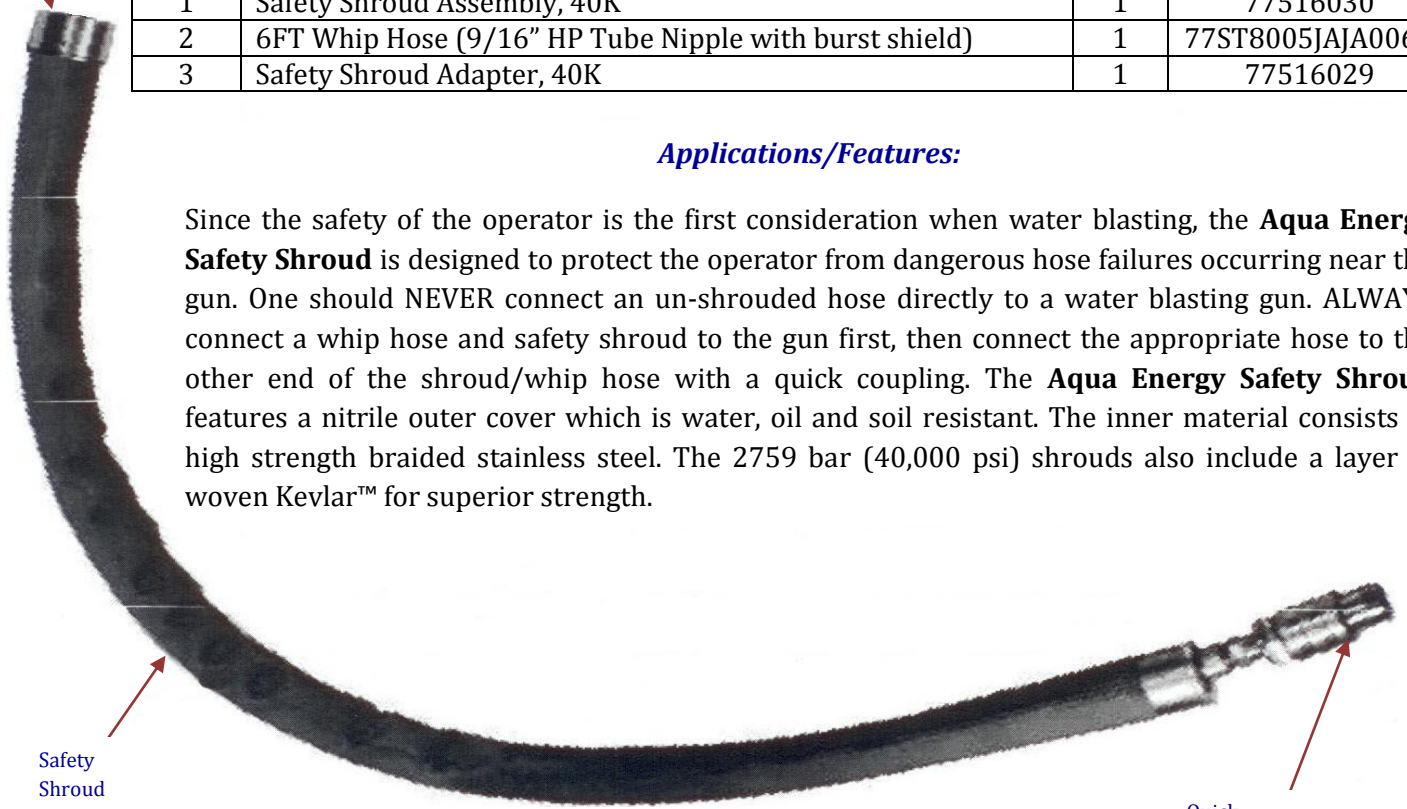

AQUA ENERGY INTERNATIONAL LTD
 28 St James Business Centre, Linwood Road,
 Paisley, PA3 3AT, Scotland, U.K.
 Tel +(44) 141 849 6888
 Fax +(44) 141 848 5777
 sales@aquaenergy.com
 www.aquaenergy.com