

AQUA ENERGY

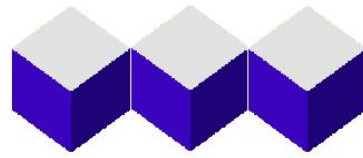

"WATERJET SOLUTIONS"

Hand-Held Zero Thrust Control Gun

Pressures to 1379 bar (20,000 psi)

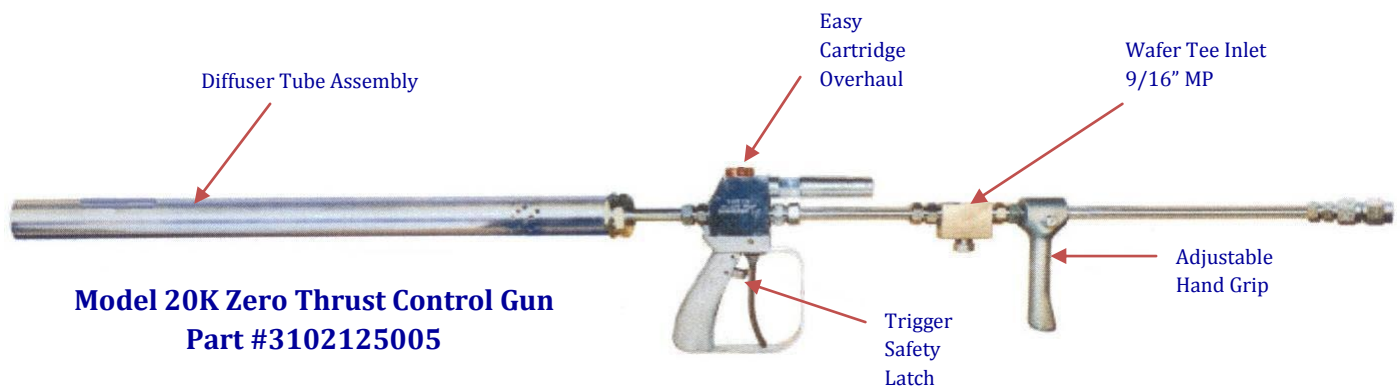

Designed for underwater or topside use where balance is critical.
The equal forward and backward thrust allows the operator to be in balance.

Constructed of stainless steel for corrosion resistance.

Vertical inlet connection for underwater use.

Adjustable hand grip.

Features 60 second cartridge overhaul.

Weighs only 7.26 Kgs (16 lbs)

60 Second Cartridge Overhaul

Remove Cartridge
Adapter

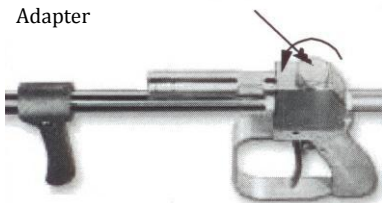

STEP 1

Align lobe on cartridge assembly
with groove in cartridge adapter
and turn counter clockwise to
unlock and remove



STEP 2

Replace cartridge
and install in block

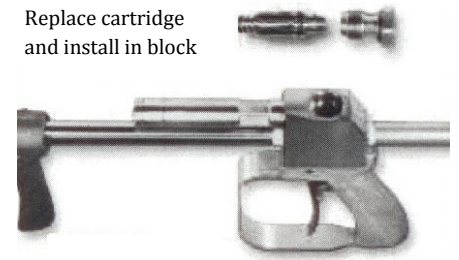

STEP 3

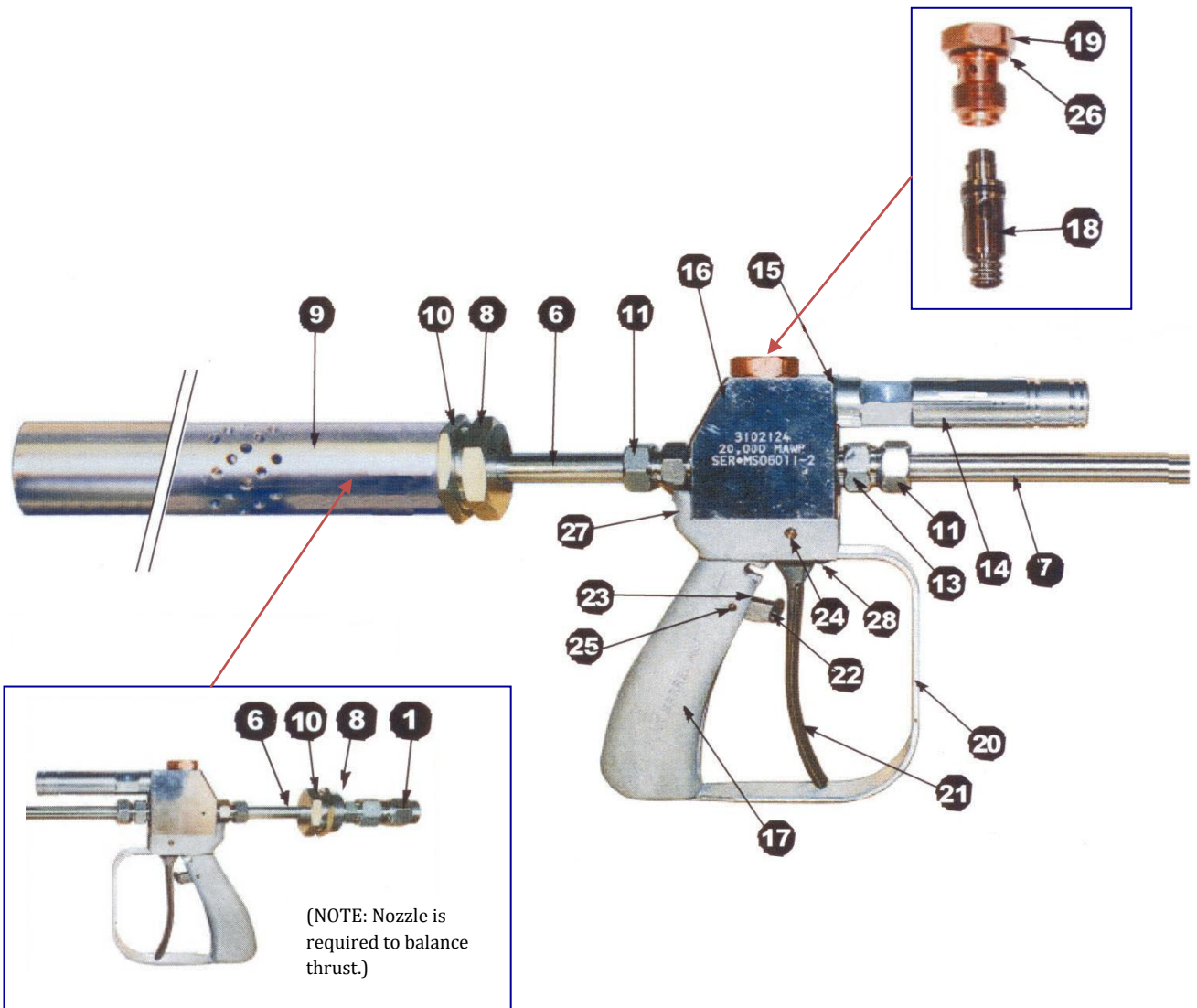

ITEM	DESCRIPTION	QUANTITY	PART NO
COMPLETE	HG Series 20K Hand Held Zero Thrust Control Gun	1	3102125005
1	Nozzle Holder	2	77600044
2	Hand Grip Frame, 9/16" Pipe	1	77513033
3	Cam Stud Assembly, 9/16" Pipe	1	77513063
4	Tee, 9/16" MP (20K MAWP)	1	77513052
5	Nipple, 9/16" NPT x 38" SS, 15K	1	77700063
6	Nipple, 9/16" NPT x 8" SS, 15K	1	77700062
7	Nipple, 9/16" NPT x 10" SS, 15K	1	77700022
8	Zero Thrust Diffuser Adapter	1	77700057
9	Zero Thrust Diffuser	1	77700058
10	Jam Nut, 1-3/4"-12"	1	77700157
11	Anti-Vibe Collet A	6	77513061
12	Gland Nut, 9/16" MP	1	77513053
13	Collar, 9/16" MP	5	77513054
14	Dump Tube, 20K USHG	1	77700613
15	O-Ring, Valve Seat	1	77700539

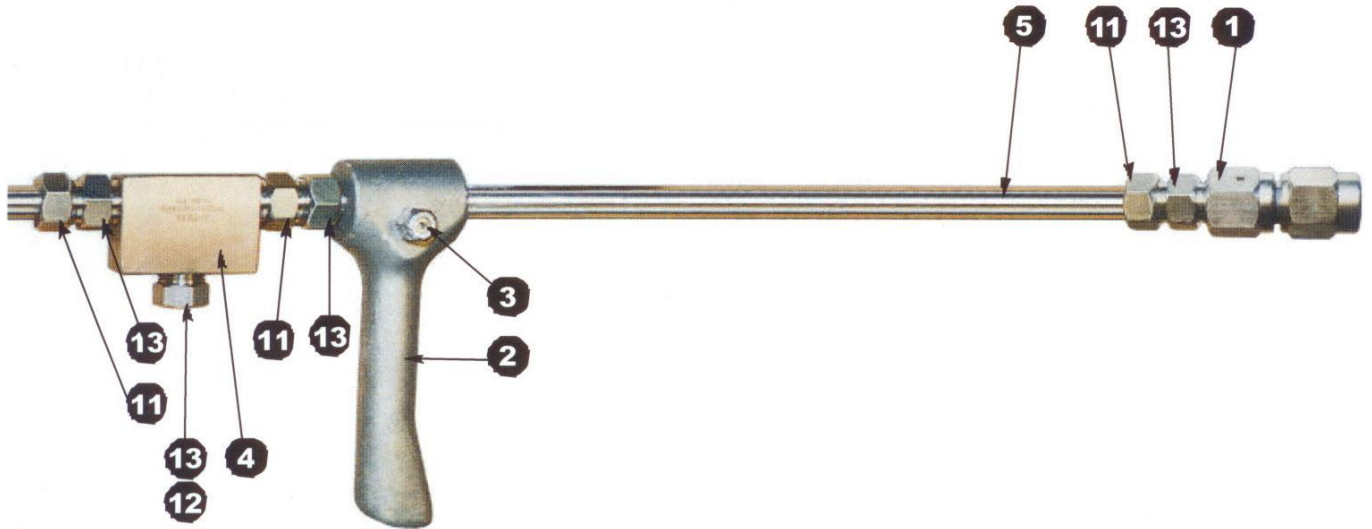
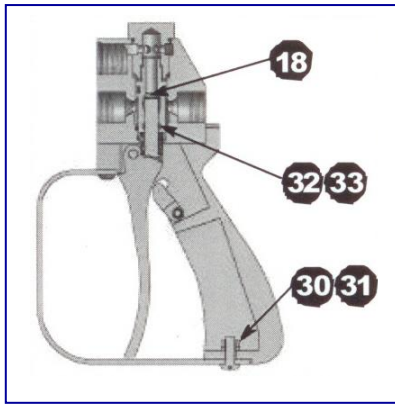

ITEM	DESCRIPTION	QUANTITY	PART NO
ASSY.	Handle Assembly (See following)	1	3102120
16	20K Dump Gun Block	1	3102124
17	Handle, 20K Dump Gun	1	77700625
18	Cartridge, Valve Assembly	1	3102121
19	Adapter, 20K Dump Gun	1	77700603
20	Trigger Guard	1	77700513
21	Trigger, 15/20K Dump Gun	1	77700617
22	Safety Latch	1	77700025
23	Spring, Safety Latch	1	77700517
24	Trigger Pivot Pin	1	77700045
25	Pivot Pin, Safety Latch	1	77700523
26	O-Ring, 1"	1	2220016
27	Screw, 1/4"-20 x 1/2" SHCS	2	77513017
28	Screw, 1/4"-20 x 1" SHCS SS	2	77700610
29	Cap Screw, 1/4"-20 x 3/4" Long	1	77408020
30	Nut, 1/4" Square	1	77700528
31	Lock Washer, 1/4"	1	77408150-3
32	O-Ring (Inside Block)	1	2217046
33	Back-Up Ring (Inside Block)	1	2217047

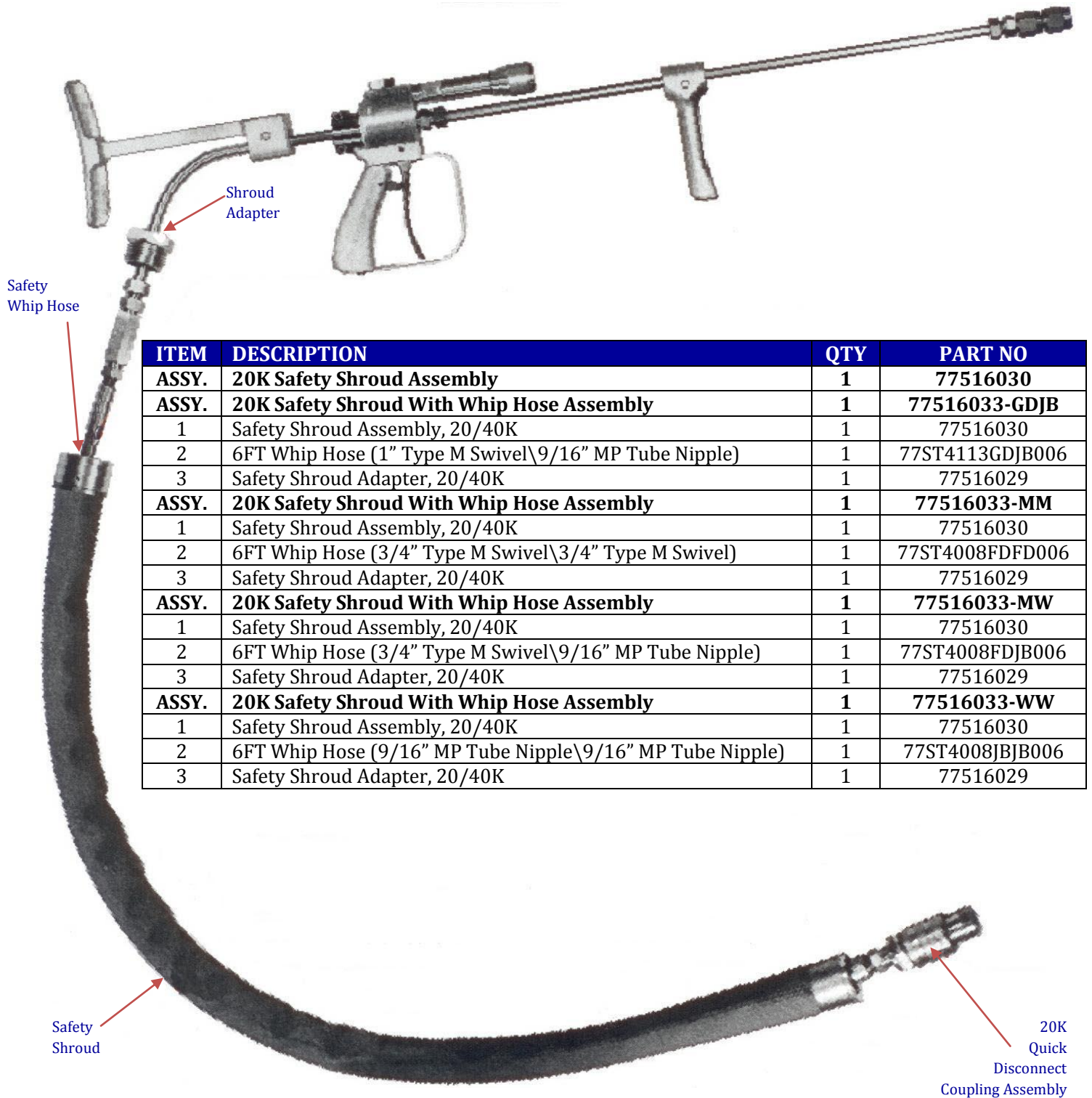

ITEM	DESCRIPTION	QTY	PART NO
ASSY.	20K Safety Shroud Assembly	1	77516030
ASSY.	20K Safety Shroud With Whip Hose Assembly	1	77516033-GDJB
1	Safety Shroud Assembly, 20/40K	1	77516030
2	6FT Whip Hose (1" Type M Swivel\9/16" MP Tube Nipple)	1	77ST4113GDJB006
3	Safety Shroud Adapter, 20/40K	1	77516029
ASSY.	20K Safety Shroud With Whip Hose Assembly	1	77516033-MM
1	Safety Shroud Assembly, 20/40K	1	77516030
2	6FT Whip Hose (3/4" Type M Swivel\3/4" Type M Swivel)	1	77ST4008FDFD006
3	Safety Shroud Adapter, 20/40K	1	77516029
ASSY.	20K Safety Shroud With Whip Hose Assembly	1	77516033-MW
1	Safety Shroud Assembly, 20/40K	1	77516030
2	6FT Whip Hose (3/4" Type M Swivel\9/16" MP Tube Nipple)	1	77ST4008FDJB006
3	Safety Shroud Adapter, 20/40K	1	77516029
ASSY.	20K Safety Shroud With Whip Hose Assembly	1	77516033-WW
1	Safety Shroud Assembly, 20/40K	1	77516030
2	6FT Whip Hose (9/16" MP Tube Nipple\9/16" MP Tube Nipple)	1	77ST4008JB006
3	Safety Shroud Adapter, 20/40K	1	77516029

Applications/Features:

Operator safety is the first consideration when water blasting, the **Aqua Energy 20K Safety Shroud** is designed specifically for use with hand held control guns. These safety shrouds protect the operator from dangerous hose failures occurring near the gun. One should NEVER connect an un-shrouded hose directly to a water blasting gun. ALWAYS connect a whip hose and safety shroud to the gun first then connect the appropriate hose to the other end of the shroud/whip hose with a quick coupling. The **Aqua Energy 20K Safety Shroud** features a nitrile outer cover which is water, oil and soil resistant. The inner material consists of high strength braided stainless steel. The 1379 bar (20,000 psi) shrouds also include a layer of woven Kevlar™ for superior strength.

AQUA ENERGY INTERNATIONAL LTD
 28 St James Business Centre, Linwood Road,
 Paisley, PA3 3AT, Scotland, U.K.
 Tel +(44) 141 849 6888
 Fax +(44) 141 848 5777
 sales@aquenergy.com
 www.aquaenergy.com